

IDENTIFICATION AND CONTROL OF A FLEXIBLE TRANSMISSION SYSTEM

Alicia Esparza Peidro

Dept. Sistemas y Automática, Universidad Politécnica de Valencia, Spain

alespei@isa.upv.es

Abstract

The identification and control of a flexible transmission using the routines available on the book website is presented in detail. Identification in closed loop is used in a second step for improving the quality of the identified model and the achieved performance of the real system. An appendix provides the results obtained with the data available on the book website for the identification of a flexible transmission (with different dynamics).

1. Introduction

The flexible transmission system is depicted in figure 1a and a view of the system is shown in figure 1b. It consists of three pulleys joined by two flexible bands. The movement of the whole system is carried out by a DC motor which is allocated next to the first pulley and produces its axis movement. This movement is transmitted to the other pulleys by the flexible linking bands. The objective of the whole system is to control the angular position of the third pulley. The DC motor has a servo-controller whose dynamics is very fast comparing to that of the pulleys¹.

The control of the system is carried out by a computer, which is connected to the flexible transmission by a input-output acquisition board, being its input connected to the position transducer, and its output to the servo of the DC motor. The software used either to gather data or to apply a controller to the system is the Real Time Toolbox of Matlab[®]. The considered sampling frequency is 20 Hz.

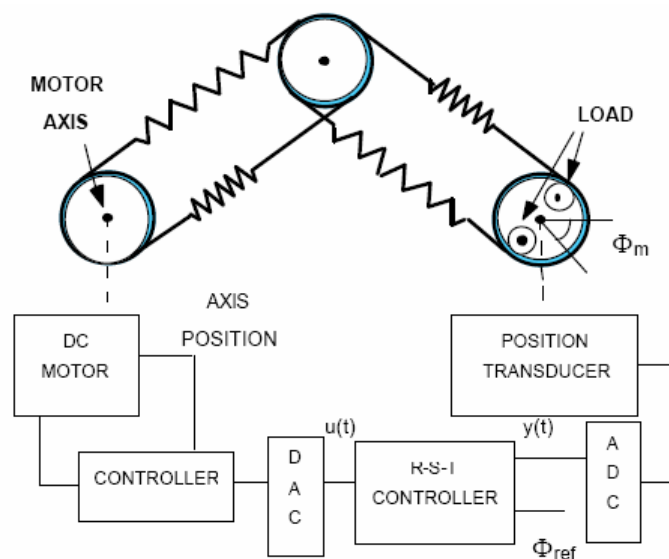

Figure 1a. Flexible transmission system

¹ This flexible transmission has different dynamic characteristics with respect to the one considered in the book “Digital control systems – design, identification and implementation” (see chapters 7, 8 and 9)



Figure 1b. View of the flexible transmission system

2. Identification in open loop

In order to obtain a model of the flexible transmission, a set of data has been gathered from the system operating in open loop (i.e. without the RST controller). The input applied to the system is a pseudorandom binary sequence (PRBS) generated with a 7 cell shift register, and a frequency divisor of 2 ($p = 2$). Two of such PRBS sequences have been applied to the plant input (i.e. a 508 data length vector). The centered input-output data gathered from the real plant is stored in the file *flextransOL.mat*.

The first decision to be made is about the order of the model. Based on the physical characteristics of the system one can think that there must be two resonant modes and thus the model order must be four. But there is another way to decide about the model order. The Matlab functions *estorderiv.m* or *estorderls.m* can be used to estimate the best order of the identified system., Using *estorderiv.m*, the result shown in figure 2 is obtained, pointing in fact at a fourth order system.

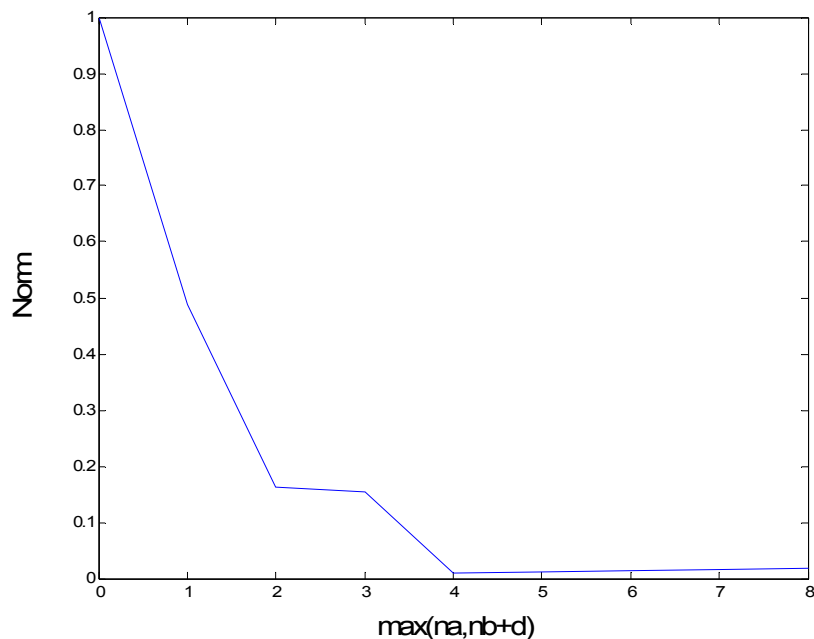

Figure 2. Model order estimation with *estorderiv.m*

A first identification using Recursive Least Squares (*rls.m*) shows that the correct model order is $n_a=4$, $n_b=3$, $d=1$. The identification and validation results are shown in figure 3.

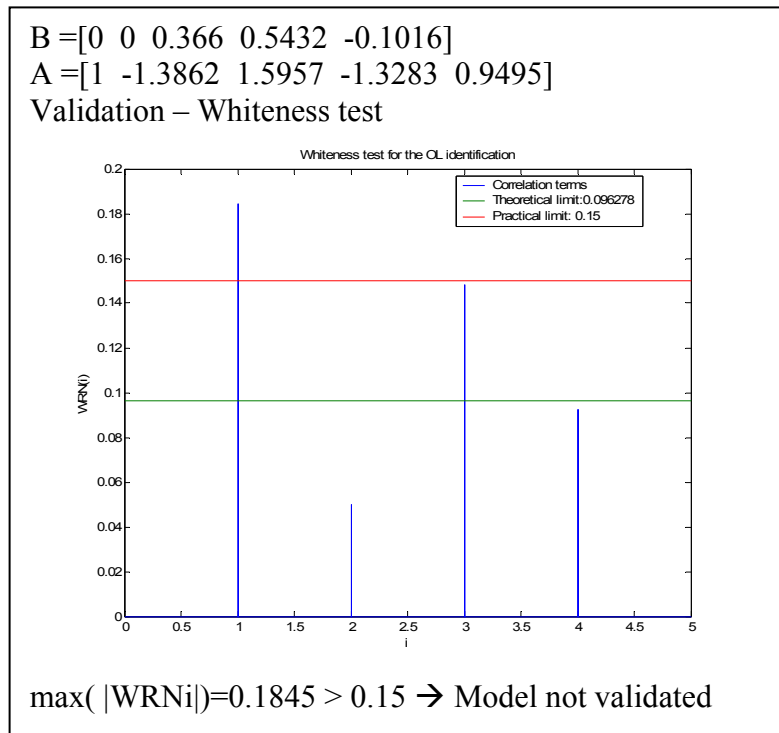

Figure 3. Results using Recursive Least Squares method

As the obtained model does not pass the validation test, a new one must be sought. Another identification method, the Extended Output Error algorithm (*xoloe.m*), is used this time, considering $n_c=n_a=4$, $n_b=3$, $d=1$. Figure 4 shows the obtained results.

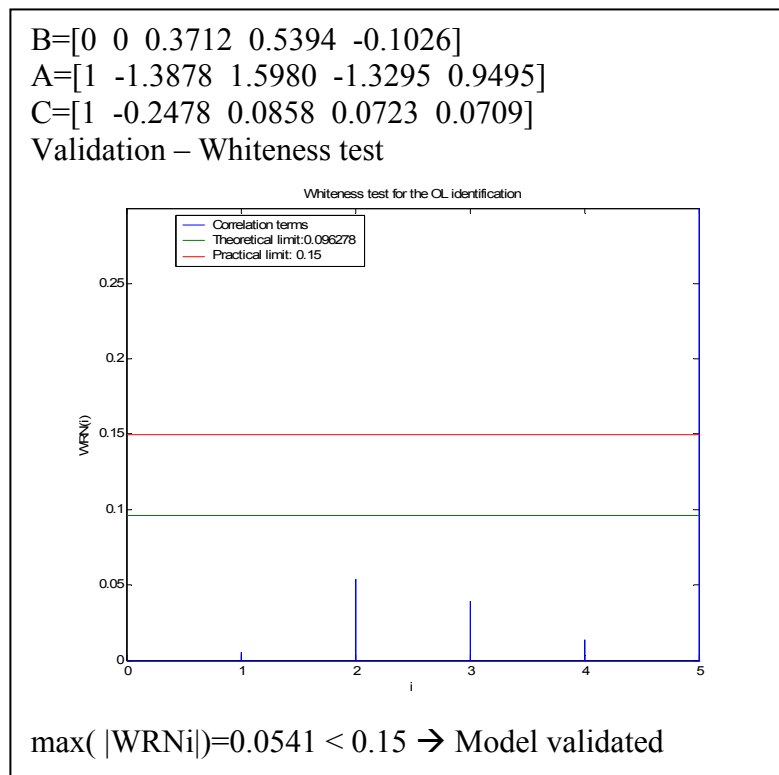

Figure 4. Results using Extended Output Error method

As can be seen, the Extended Output Error algorithm in open loop has succeeded in identifying a model for the plant.

3. Controller design

Once the plant has been identified, a controller can be designed in order to provide a good closed loop behavior. To do this, the pole placement methodology has been chosen, and the Matlab program *ppmaster* has been used. The specifications are:

- Robustness: Modulus margin greater than 0.5, delay margin greater than a sampling period.
- Regulation dynamics:
 - Dominant poles: two complex conjugate poles at the same frequency as the plant first resonant mode, but with a damping factor of 0.8.
 - Two auxiliary complex conjugate poles at the same frequency as the second resonant mode, with a damping factor of 0.15.
 - One integrator and one zero at -1, the last opening the loop at high frequencies.
 - Four additional auxiliary poles at 0.3.
- Tracking: it is considered $T=P(1)/R(1)$, and the same dynamics as for regulation (so $A_m=B_m=1$).

The computed controller is displayed in figure 5.

$R=[0.1699 \quad -0.0820 \quad -0.3855 \quad 0.2233 \quad 0.2784 \quad -0.0785]$ $S=[1 \quad -0.7918 \quad -0.2365 \quad -0.0281 \quad 0.0651 \quad -0.0086]$ $T=0.1255$
--

Figure 5. RST controller obtained by pole placement

The system's closed loop step response has been simulated using *Simulink*. The block diagram is shown in figure 6. All the corresponding transfer function blocks are discrete filters (whose coefficients are ascending powers of z^{-1}).

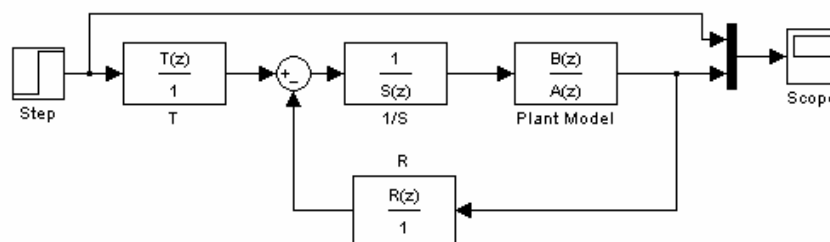

Figure 6. *Simulink* block diagram used for simulation

The simulated and the real closed loop behavior are shown in figure 7, where a big difference between the designed and the achieved closed loop is evidenced. This means that the plant model is not good enough in the frequency regions where the controller is operating. So a new identification is needed. Then a closed loop identification will be carried out for improving the model quality.

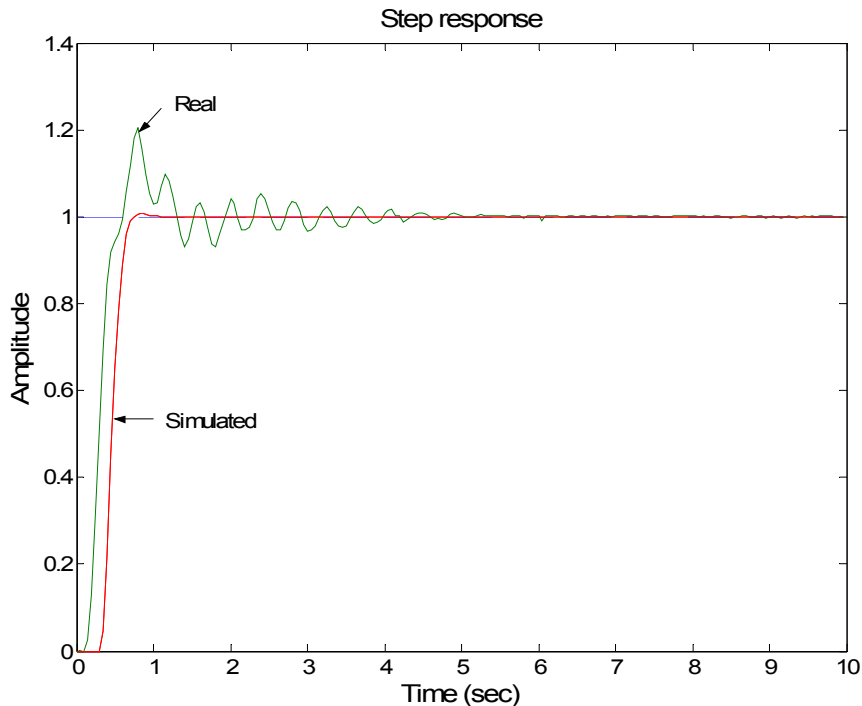

Figure 7. Simulated and achieved closed loop behaviour with the RST controller

4. Identification in closed loop

To identify a new model which explains the observed closed loop behavior, a new identification experiment is carried out. The experiment has been done in closed loop, using the RST controller designed above (file *RSTfirst.mat*). The reference has been imposed to zero, and the same PRBS as that used for the open loop identification procedure has been applied to the plant input (*ru*, as shown in figure 8). The gathered data have been recorded in the file *datIDCL.mat*. This file stores the excitation signal (*ru*), the plant input (*u*) and its output (*y*).

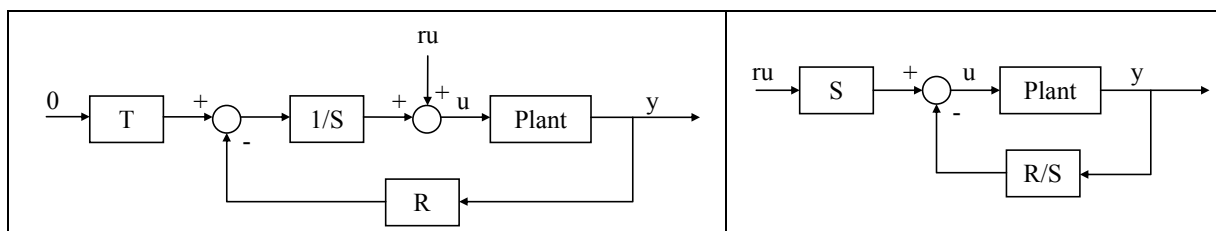

Figure 8. Closed loop identification setup. Equivalent schemes

To identify a new model, the Closed Loop Output Error with Adaptive Filtered Observations (*afcloe.m*) algorithm is used, with the previously designed RST controller and the same orders as for the open loop identification. As the excitation signal is applied to the controller output, in *afcloe.m* function *T* must be set as *S* (see figure 8). The first identification gives the following parameters:

$$B=[0 \ 0 \ -0.036856 \ 0.5315 \ 0.280623]$$

$$A=[1 \ -1.47514 \ 1.68418 \ -1.3321 \ 0.90536]$$

One can see that the first parameter of B is negligible with respect to the other ones. So, the identification is repeated with $n_a=4$, $n_b=2$, $d=2$. In order to validate the plant models identified in closed loop, the whole closed loop is identified in open loop, using the recorded signals y and ru . To carry out this identification, an OLOE method has been used with the orders $n_a=9$, $n_b=7$, $d=2$ (the same orders as the computed closed loop system). As the resulting model passes the open loop correlation test, its poles have been considered for comparison with the following closed loop identified plant models.

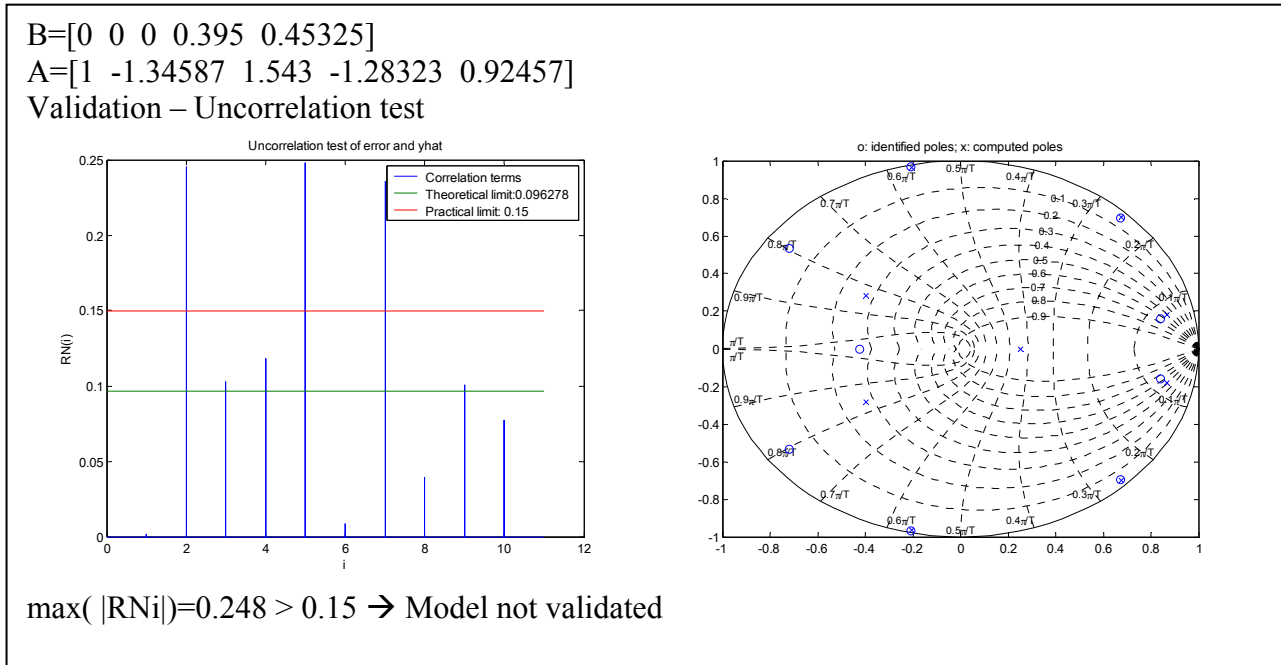

Figure 9. AFCLOE model

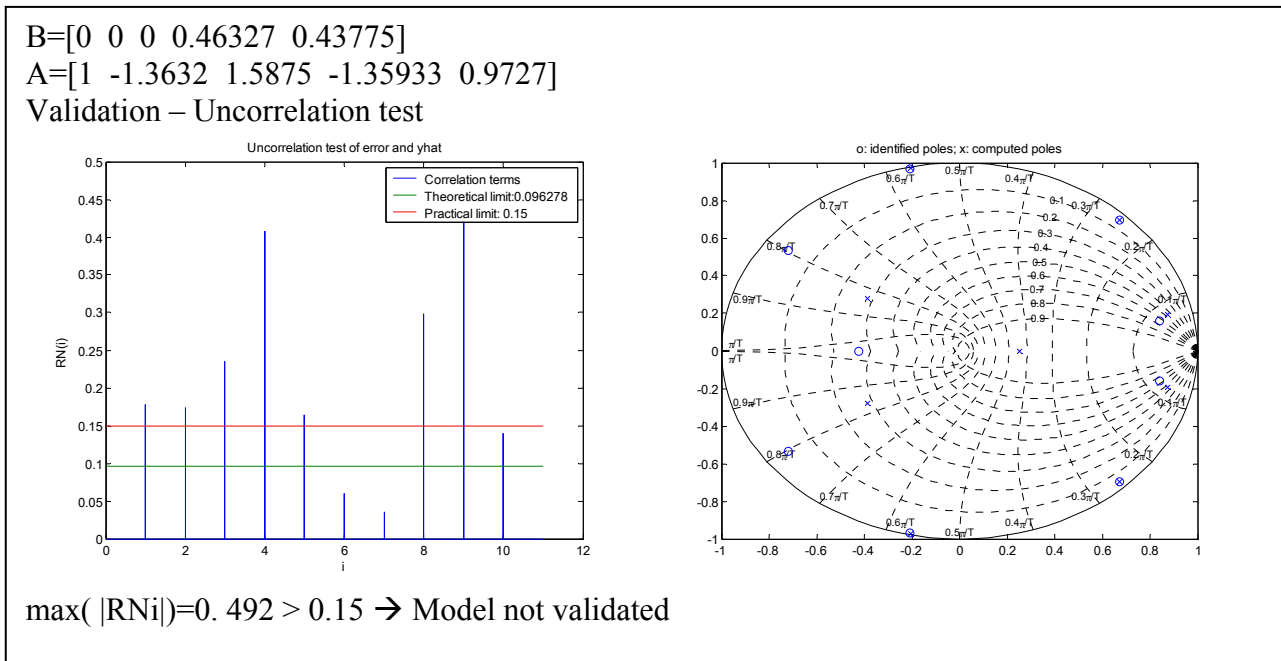

Figure 10. FCLOE model

The result of the new plant identification using the AFCLOE method is not successful, as shown in figure 9, and a Closed Loop Output Error with Filtered observations (*fcloe.m*) algorithm is tested, using the model previously identified with the AFCLOE method as the

starting one. The model identified using the FCLOE method does not validate either (figure 10).

Due to the unsatisfactory results it is necessary to try another algorithm: the Extended Closed Loop Output Error (XCLOE) is then used. This one finally succeeds in providing an acceptable model, as shown in figure 11. From this figure and in the previous figures, it is possible to observe that the closed loop poles computed on the basis of the identified plant model are very similar to those of the closed loop model identified in open loop. With the XCLOE one has the dominant poles (those on the right part whose natural frequency is less than $0.1\pi/T_s$) very close to the dominant poles of the identified closed loop.

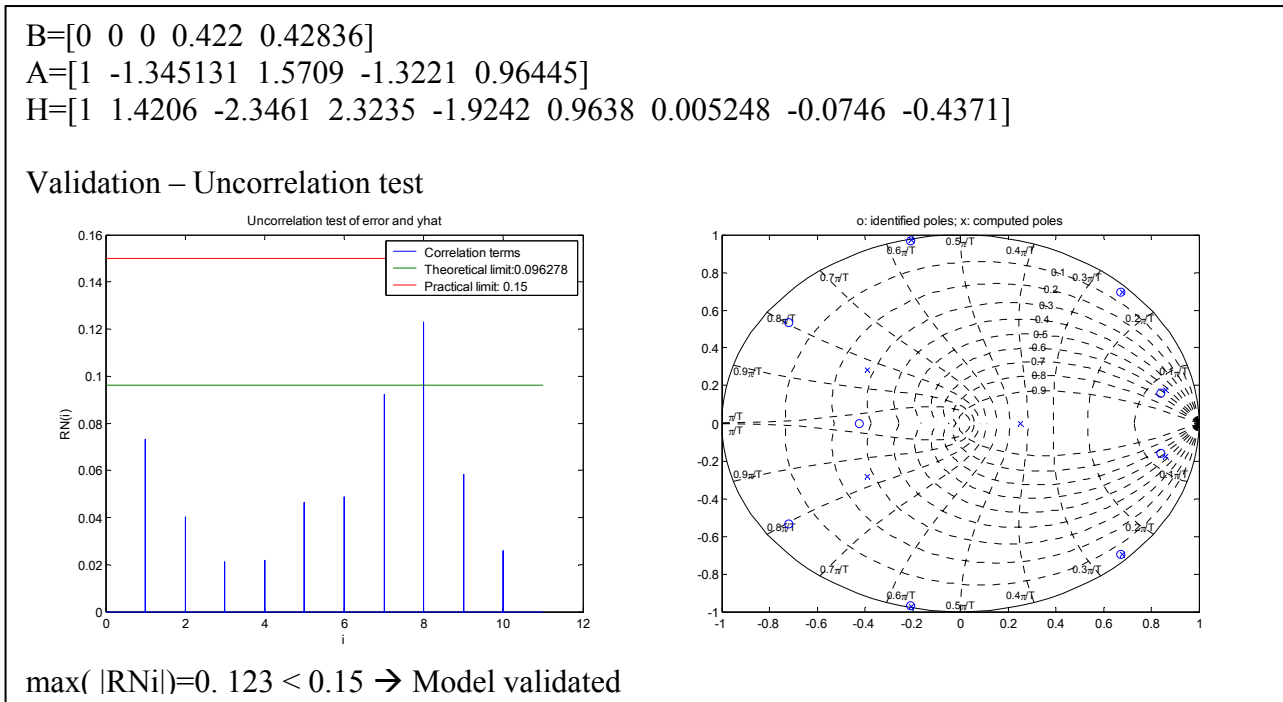

Figure 11. XCLOE model

Figure 12 shows the frequency response of both identified models: the one identified in open loop is drawn in dashed blue line and the identified in closed loop is in solid red line.

5. Controller design

Again, a controller is designed using *ppmaster*, and following the same specifications as in section 3. This time, the considered model is that identified in closed loop using the XCLOE method (see section 4). The controller parameters are stored in the file *RSTmodXCLOE.mat*, and are:

$$\begin{aligned}
 R &= [0.27398 \ -0.61997 \ 0.098565 \ 0.56366 \ -0.284801 \ 0.14405] \\
 S &= [1 \ -0.50522 \ -0.34574 \ -0.06082 \ -0.024237 \ -0.06398] \\
 T &= 0.17547
 \end{aligned}$$

The expected and the achieved step responses are depicted in figure 13, where just a slightly difference can be observed.

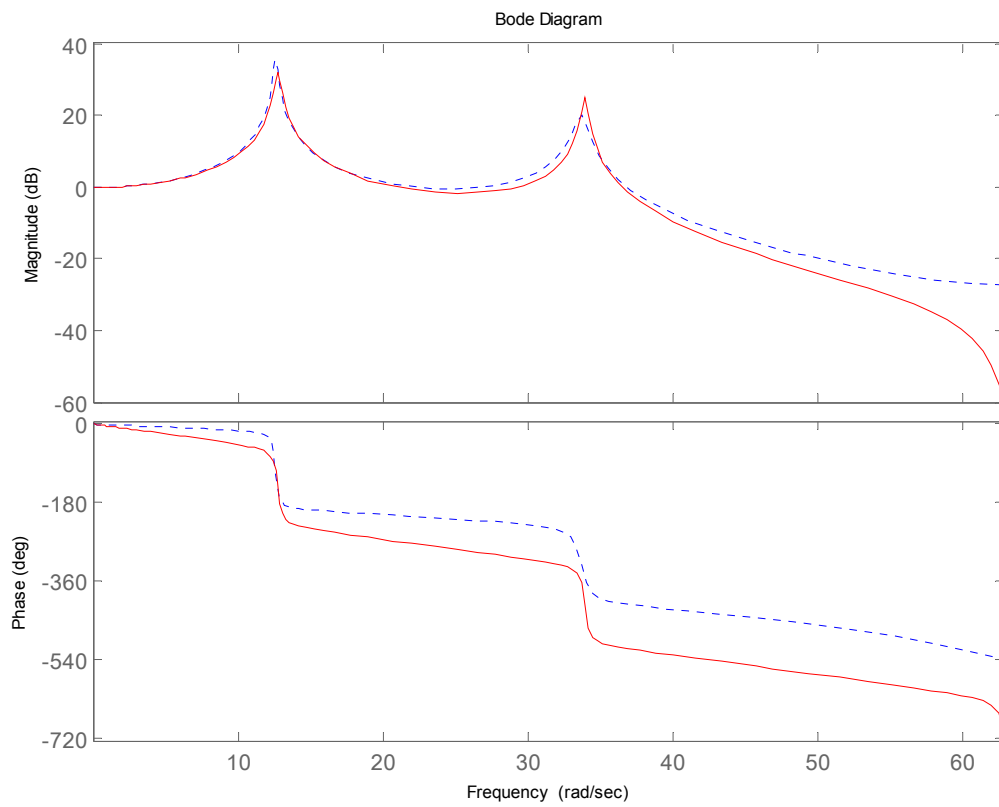

Figure 12. Comparison between the open loop (dashed) and the closed loop (solid) identified models

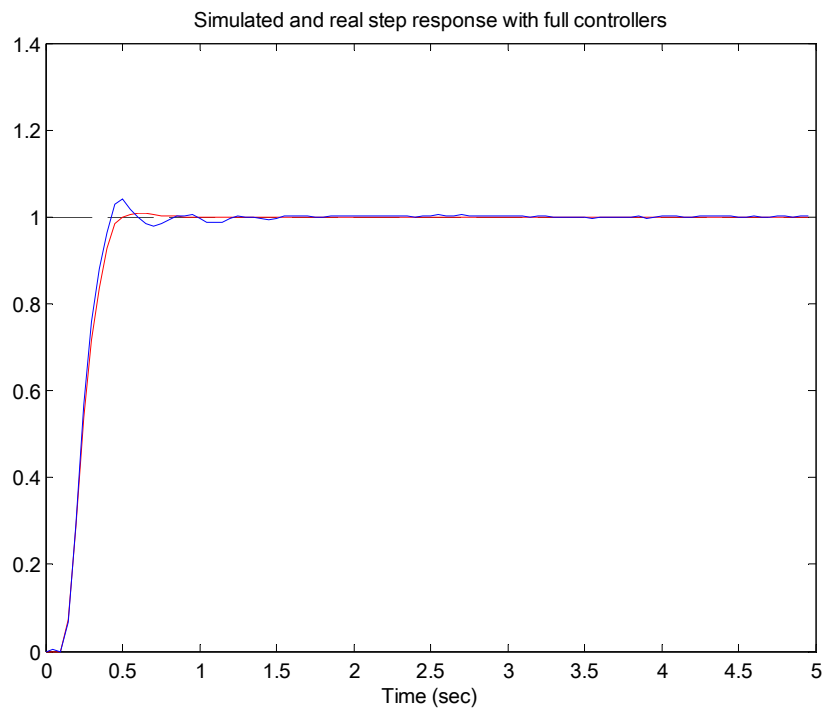

Figure 13. Simulated (red) and real (blue) step responses with the RST controller designed considering the closed loop identified model

6. Appendix: Identification of the flexible transmission in closed loop using the data from the website

In this section, the closed loop identification of a model for the flexible transmission is revisited using the data available on the book's website. The same file with the centered data has been renamed (*flexbook_ibfdat.mat*). The RST controller used to gather the data in closed loop operation is stored in the file *RSTflexbook.mat*.

The whole closed loop is identified in open loop in order to compare its poles with those computed with the new plant model. To obtain this model a XOLOE has been applied, with the orders $n_a=8$, $n_b=6$, $d=2$.

The first identification is carried out using the AFCLOE method, and the results are shown in figure 14.

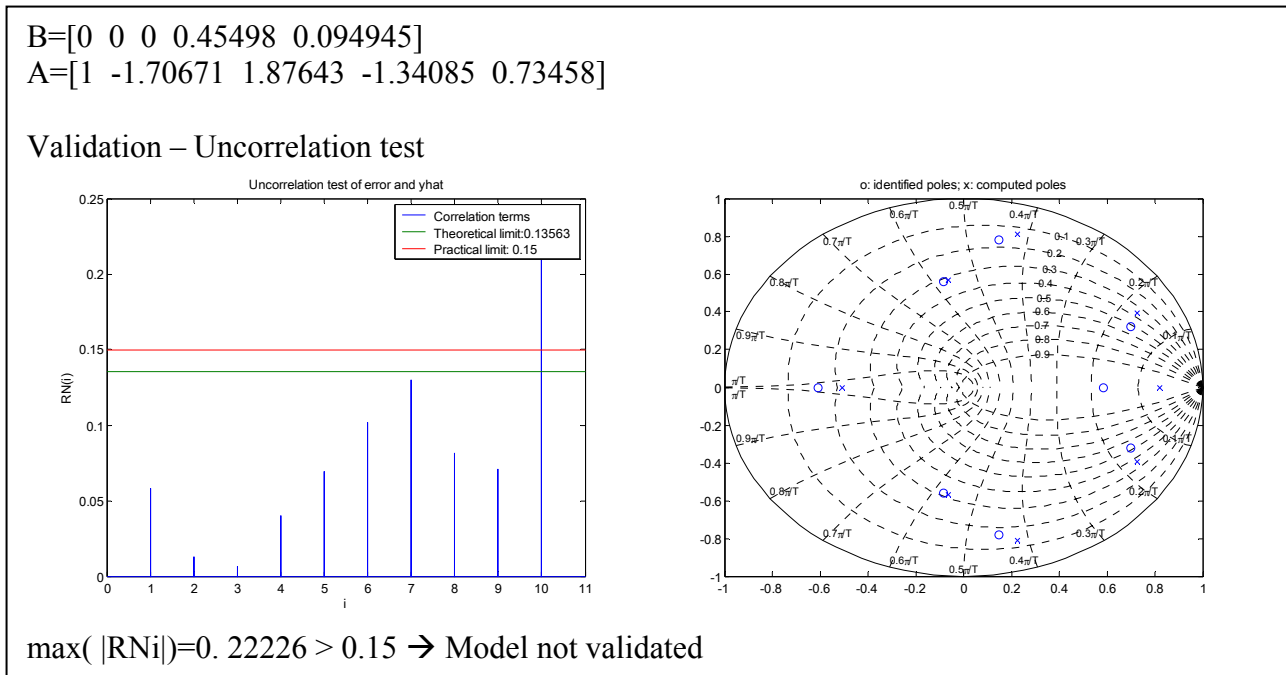

Figure 14. Results for the model identified using the AFCLOE algorithm

Then a CLOE algorithm is tried out, giving the results shown in figure 15. It's worth to point out that the closed loop poles are more far away from the identified ones than the previous model. The maximum value of the uncorrelation test is also worse than the previous one.

The following step is to try to identify the plant model using the FCLOE method, considering the previously identified AFCLOE model as the starting one for this new identification. The result is shown in figure 16. This model is validated, and it is possible to observe in the plot on the right that the dominant closed loop poles (those with a natural frequency less than $0.2\pi/T_s$) are closer to the identified ones than the models previously identified in this section.

$$B=[0 \ 0 \ 0 \ 0.4186 \ 0.25352]$$

$$A=[1 \ -1.50385 \ 1.563714 \ -1.0651 \ 0.6292]$$

Validation – Uncorrelation test

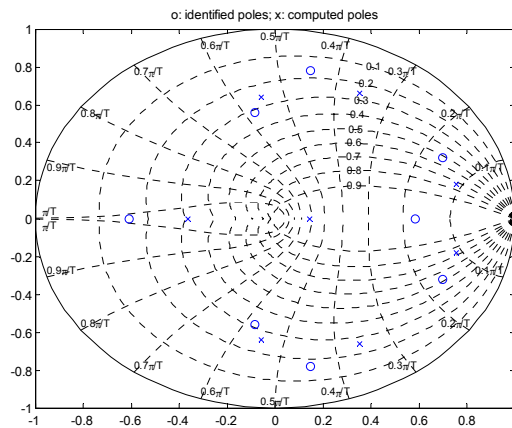
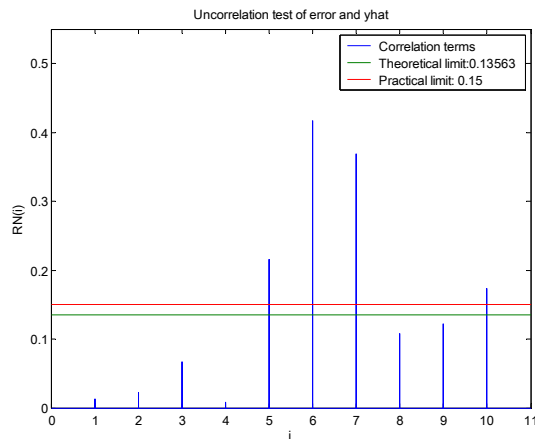

$\max(|RN_i|)=0.41696 > 0.15 \rightarrow$ Model not validated

Figure 15. Results for the plant model identified with the CLOE algorithm

$$B=[0 \ 0 \ 0 \ 0.43534 \ 0.31576]$$

$$A=[1 \ -1.51586 \ 1.732466 \ -1.37422 \ 0.85366]$$

Validation – Uncorrelation test

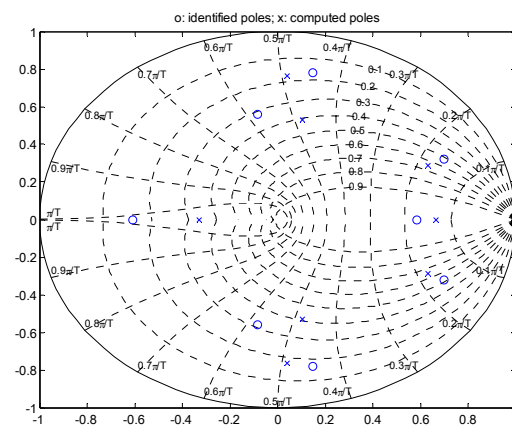
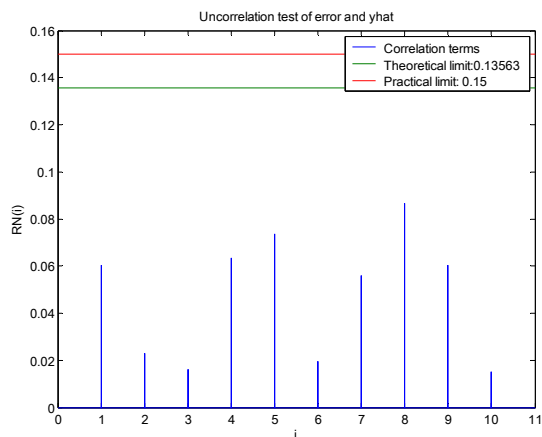

$\max(|RN_i|)=0.086726 < 0.15 \rightarrow$ Model validated

Figure 16. Results for the plant model identified using the FLOE algorithm

Acknowledgment

This work was sponsored by Investigation Incentive Programme of the Universidad Politécnic de Valencia (Spain) and has been done at Laboratoire d'Automatique de Grenoble (CNRS/INPG/UJF).